

Fan Installation, Operation & Maintenance

How to Avoid Problems with Your Fan

Introduction

This document presents ways to avoid the most common fan problems caused by improper storage, installation, operation and maintenance. Installation, operation and maintenance manuals give general instructions on what and what not to do. This document will give more detail as to why these steps are important.

Storage

Many fans do not have the chance to operate successfully simply due to their treatment and handling during shipment and storage. Rough handling during shipment and improper storage can cause damage that is not noticeable until the fan is in operation. Fans are frequently received on site well before they are put into operation. This often happens on large projects where the fan is set in place and then sits idle while the rest of the project is completed. Sometimes several months go by before the fan is started.

It is discouraging to buy a new fan, only to have problems shortly after startup. This can be avoided with proper storage techniques which drastically reduce the likelihood of having problems.

Most problems associated with storage are due to moisture getting into the bearings. The best way to avoid moisture problems is to store the fan in a clean and dry place, preferably indoors. Outdoor storage usually subjects the fan to variations in temperature and humidity. As the temperature drops, moisture condenses as dew. Condensation in the bearings can cause rusting of internal bearing surfaces, known as puddle corrosion.

If fans cannot be stored in a controlled environment, avoid puddle corrosion by packing the bearings full of grease. This eliminates the air pockets where moisture can condense. Many greases contain rust inhibitors. Adding new grease every month adds more of these inhibitors. Turn the shaft about ten revolutions while adding the grease to make sure that all surfaces inside the bearings are coated. Stop the shaft in a different location than it was previously stopped at. This way if any moisture does develop, it will not always be at the same location. On fan startup the extra grease will purge out of the bearings. This may make a mess, but it is better to deal with a mess than with a bearing failure. With split bearings, the caps can be removed prior to startup to remove excess grease.

Another good idea is to add grease to the outside of the bearing seals as this will help seal out moisture.

It is not possible to add grease to some small fans and motors that have “sealed for life” bearings. In this case, rotate the shaft monthly.

Reduce the belt tension on belt driven fans. This reduces the load on the bearings, minimizing the potential for problems.

Do not store the fan in a location where it will be subjected to vibration. Vibration may cause internal surfaces to rub against each other, damaging the bearings. Damage of this type usually does not cause a problem right away; it may take a couple of months of operation for it to develop.

Fan Foundations

The structure that supports the fan must be strong enough to support the loads produced by the fan. Many “fan” problems are actually structural support problems. The support must be designed to carry both the dead weight of the fan and dynamic loads created while the fan is operating.

A well-designed fan support is rigid enough to keep vibration levels low. Before discussing the features of good fan support design, we need to set up some background information on vibration:

Vibration is the repetitive motion that results from forces that vary in amplitude or direction over time. One common cause of vibration is impeller imbalance. Impeller imbalance is a result of the centrifugal forces acting on an impeller whose center of gravity is offset slightly from the center of rotation. Not all vibration is bad. Only when the vibration levels exceed certain amplitudes is it a problem. A well-balanced impeller has its center of gravity close enough to the center of rotation that the vibration levels are low.

Excessive vibration causes problems in many different ways. It causes lubricant to break down, which allows metal to metal contact of bearing surfaces, which then results in premature bearing failure. It can also cause fatigue cracks in the bearings, the bearing supports, or other fan components. It can cause fasteners, such as motor and bearing hold down bolts or the set screws that hold the bearings and impeller to the shaft to work themselves loose. Many precision processes, such as the manufacturing of computer chips, cannot tolerate high levels of vibration. In other installations, sound caused by vibration can be annoying to the people who must work nearby.

Vibration Spectrum Plots

Figure 1.

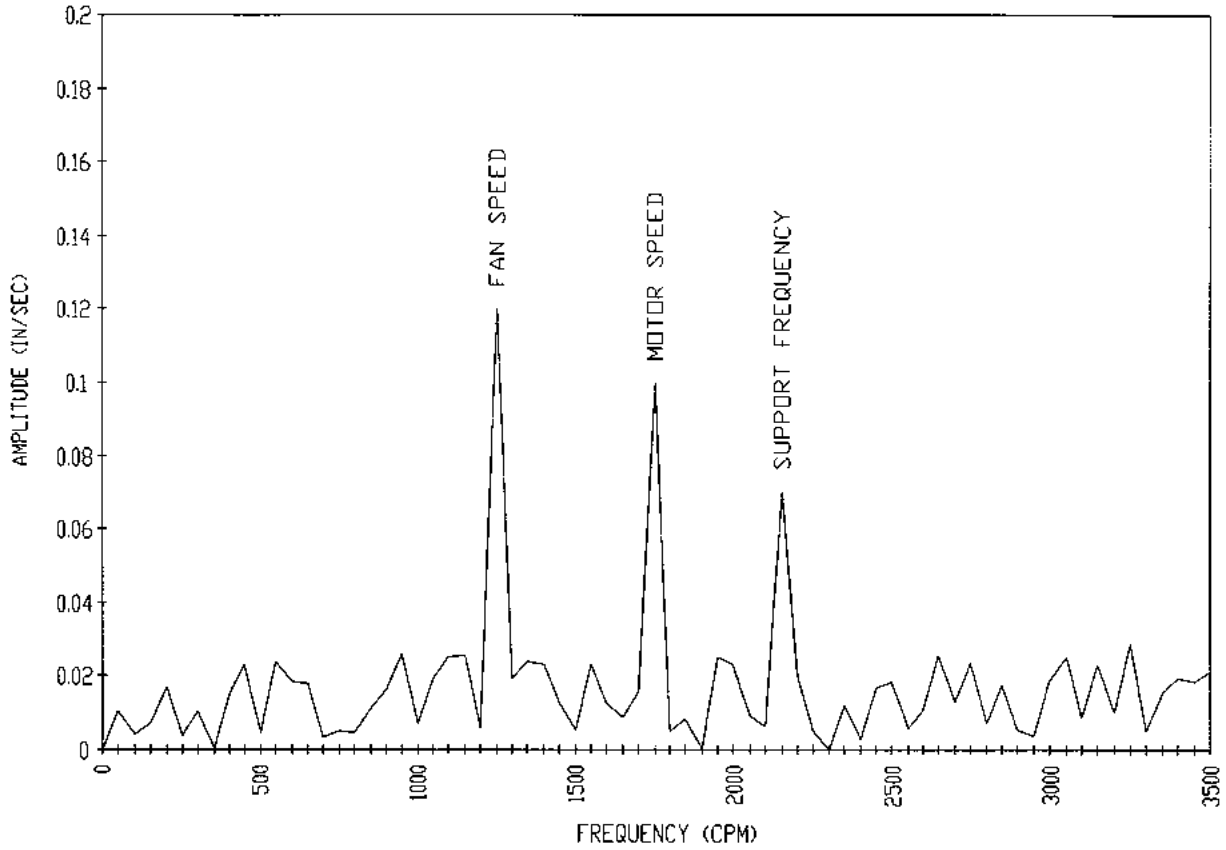
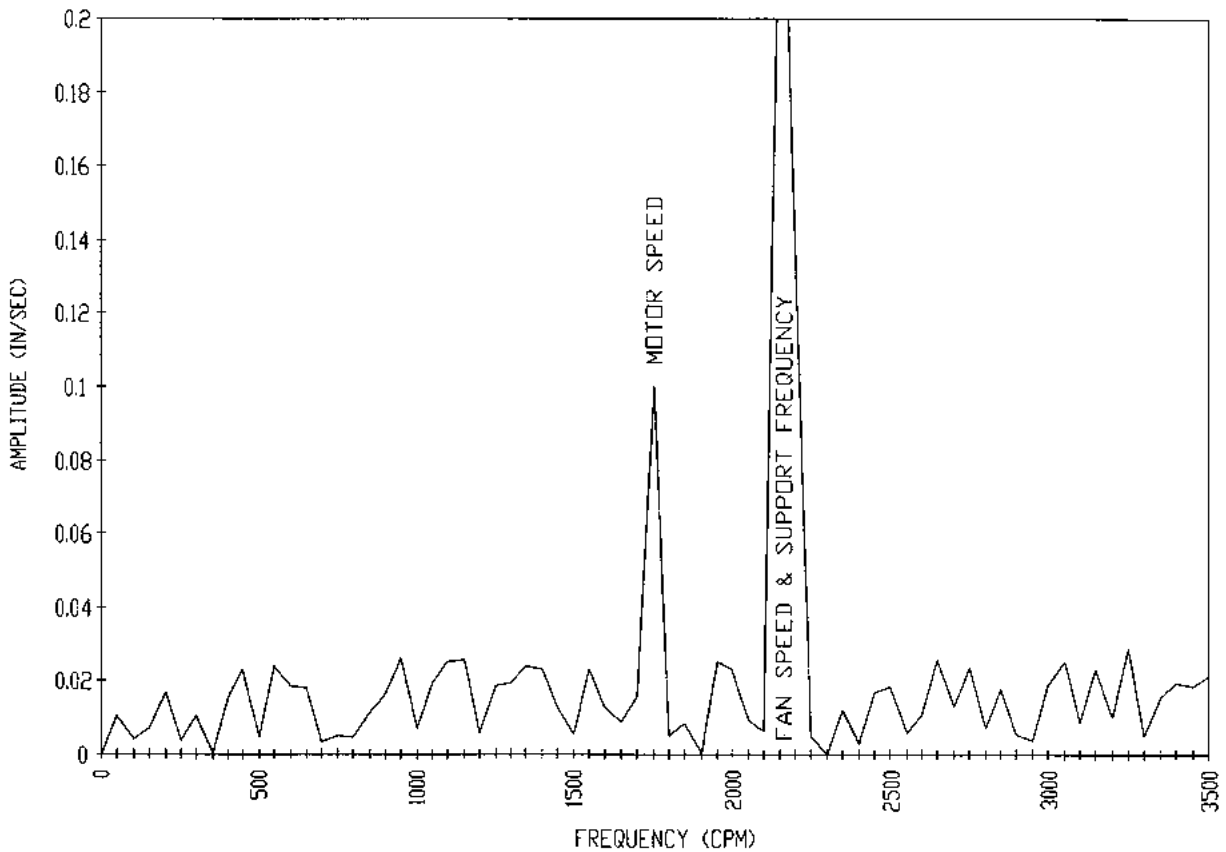

Figure 2.



Fan Vibration

Figure 1 shows the plot of a vibration spectrum, which is a plot of vibration amplitude versus frequency. These plots are used by vibration technicians to diagnose vibration problems and the general condition of rotating equipment. The amplitude relates to how “loud” the vibration is and the frequency relates to its “pitch.” Amplitude can be expressed in terms of acceleration, velocity, or displacement, all three of which are related mathematically. When dealing with fans, it is convenient to use cycles per minute for the frequency because it is easier to identify the vibration levels at the fan and motor speed. Common units for vibration amplitude and frequency are shown in Table 1.

Table 1. Common Units For Vibration Analysis

MEASUREMENT	UNITS
Peak-to-Peak Displacement	mils (1 mil = .001 in.)
Peak Velocity	inches / second (ips)
Acceleration	g (1 g = 32.2 ft/sec ²)
Frequency	Cycles per second (Hz)
Frequency	Cycles per minute (cpm)

The spectrum in Figure 1 is for a fan operating at 1250 revolutions per minute (rpm = cpm), driven by a motor operating at 1750 rpm. If we were to increase the fan speed, the spike corresponding to the fan speed would move to the right. If we were to slow it down, the spike would move to the left.

Spikes will also be present at the natural frequencies of the structure. Just as bells or tuning forks have distinct natural frequencies they “ring” at, structures have natural frequencies. The fan support in Figure 1 has a natural frequency at 2200 cpm.

Resonance

When the fan speed corresponds to the structure’s natural frequency, the fan and structure are in resonance. At resonance, small forces can produce high levels of vibration. Even a well-balanced fan can produce high vibration levels at resonance with a structure’s natural frequency. Figure 2 shows what happens when the fan speed from Figure 1 is increased to 2200 rpm. As you can see, the vibration level at this frequency increases dramatically at resonance. Sometimes the vibration can be lowered by balancing the fan to an even finer balance, but the fan and structure will be very sensitive. A small amount of dust buildup on the impeller, for example, will cause the vibration level to increase again.

In order to avoid problems with resonance, the support structure for a fan should be designed so that the natural frequency of the structure is at least 20% higher than the fan speed. When mounting a fan on an existing structure, verify that the natural frequency is high enough by having a vibration technician perform a “bump” test. A bump test is simply striking the structure and measuring the frequencies at which it rings. If there is a natural frequency too close to the fan speed, stiffen the structure so that the natural frequency increases to the point where it will not be a problem.

The best foundation for mounting a fan is a flat, rigid concrete pad that has a plan area of at least twice the plan area of the fan and is thick enough that the weight of the pad is at least three times the weight of the fan. To keep the edges of the pad from breaking away, they should be kept at least six inches from the fan. The large weight of the pad compared to any forces resulting from an imbalance of the impeller ensures that the

Figure 3. Concrete Pad Anchor

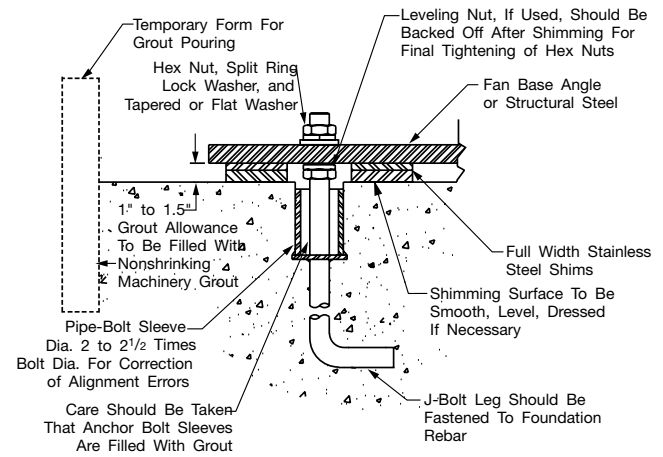

vibration levels will be low. Also, because concrete pads are so rigid, their natural frequencies are usually very high, which avoids resonance problems.

Figure 3 shows the best way to anchor a fan to a concrete pad. “T” or “J” bolts provide a strong, rigid connection to the pad. The pipe sleeve allows for some flexibility in case the bolt location does not exactly match the hole in the fan base. Compression type anchor bolts are sometimes used, but they can work loose when subjected to loads caused by vibration. To avoid this problem when using these types of anchors, use as large a size as possible.

When the fan is anchored to the pad, level it using shims. Use 1" to 1½" thick shims between the fan base and the concrete pad. After leveling the fan, build dams around the pad and fill the gap made by the shims with grout. Grout is a masonry product, similar to the grout used to set ceramic tile. There are many varieties of grout, from mortar types to epoxy types. Epoxy grout, while more expensive, is more durable and more resistant to oil and moisture than cementitious grout. After the grout has set, double check that all of the anchor bolts are tight.

Often it is not practical to mount fans on concrete pads and they are mounted on structural steel supports. With steel supports it is essential that they be designed for rotating equipment. It is not only important to consider dead loads and natural frequencies, but the support must be rigid enough to keep drive belts or couplings aligned. One way to make the design easier is to locate the fan as close to walls or vertical columns as possible. Roof mounted fans are a special case of mounting fans on structural steel supports. The difference is that the steel structure is covered by the roof. The same design criteria must be used.

When mounting the fan on a structural steel base there may be gaps between the fan base and the structural steel base. This occurs because structural steel is not perfectly flat and neither are the bases of fans. Fill any gaps with shims before tightening the fan to the steel base. Since most fan designs have relatively close clearances between the impeller and fan housing, tightening the fan to the base without shims can distort the fan so that the impeller rubs against the housing.

Vibration Isolation

This is a topic that is somewhat controversial in the fan industry. There are those who advocate a “total system” concept of evaluating a fan and its support system. This type of analysis looks at the support of a fan impeller

component by component all the way down to the footings and foundation of the building. Looking at the total system, the structure is designed to avoid resonance without the need for vibration isolators. From a technical point of view, this is the correct way to design fan support structures. This concept has been used successfully on vibration sensitive fan applications such as the manufacturing of computer chips.

The other approach is to use vibration isolators between the fan and the supporting structure. These isolators, when properly selected, reduce vibration forces transmitted to the structure by approximately 95%. This much reduction reduces the likelihood of having a resonance in the support structure. Depending on the fan speed, isolators are selected to have a specified amount of deflection when put under load. For example, a spring selected to deflect 1" under load on a fan operating at 1200 rpm will reduce the forces transmitted to the support by 97%. Various isolator designs, such as metal springs and rubber-in-shear, are available to accommodate different loads and speeds.

Advocates of "total system" design point out that selecting isolators based only on the vertical load is an oversimplification. Fans mounted on isolators not only move up and down, but rock back and forth and move side to side. These additional motions end up increasing the loads transmitted to the structure, resulting in less "isolation," and can cause problems. On the other hand, vibration isolators work successfully in the majority of cases.

Figure 5. Fan mounted on an inertia base



Figure 4 is a photograph of a fan and motor mounted on a structural steel base supported by spring vibration isolators. Like other fan support structures, the base must be rigid and designed without natural frequencies near the fan or motor speeds. Notice the routing of the electrical conduit to the motor. It is flexible and takes into account the movement of the motor.

Figure 5 shows an inertia base type of vibration base. It is similar to the base in Figure 4, except that the base is filled with concrete. The weight added by the concrete creates inertia, reducing the amount of vibration. The concrete also makes the base very stiff, making it easier to design to avoid resonance. The disadvantage of this type of base is that the isolators and the structure supporting the fan and base must be designed to carry the extra weight of the concrete base.

Figure 4. Fan mounted on a structural steel base with spring vibration isolators

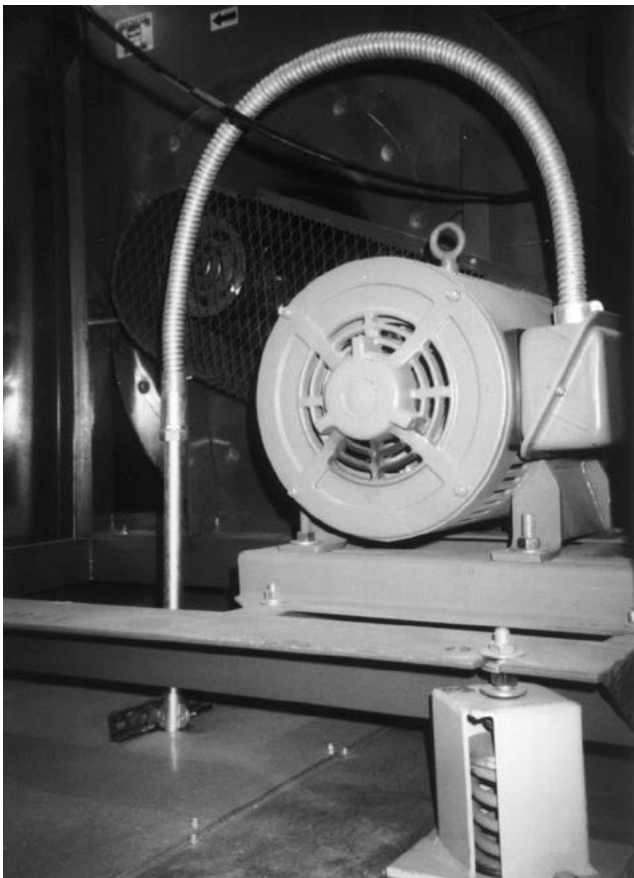
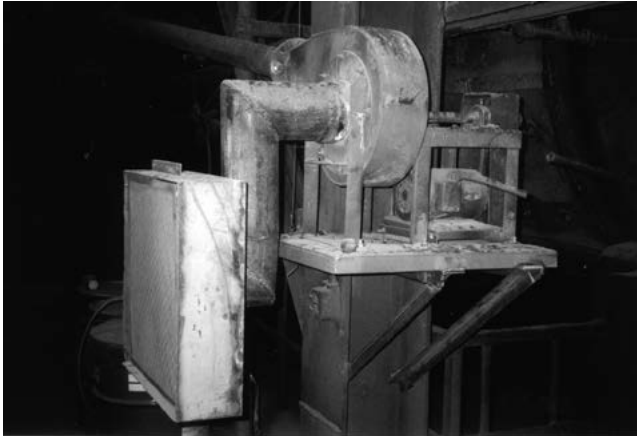

Figure 6. Well-designed duct configuration



Figure 7. Poorly-designed duct configuration



Duct Connections

Any time ductwork is connected to a fan, it is important to consider any effects the duct may have on fan performance. Catalog fan performance is based on uniform flow entering the fan and a straight run of duct on the discharge. Many duct configurations do not provide these flow conditions and as a result, the fans will not perform at catalog levels. This loss in performance is known as “system effect.” Figure 6 shows a well-designed duct configuration that will not have any system effects, while Figure 7 shows a poorly-designed duct configuration that will lose performance due to system effects. For more information on system effects and methods for estimating their effect on performance, see AMCA Publication 201.

Fans mounted on vibration isolators need to have flexible connections between the fan and the ductwork. Without flexible connections, the ductwork would prevent the movement of the fan on its isolators, reducing the effectiveness of the isolators. In addition, rigid connections transmit fan vibrations to the duct, opening up the possibility of exciting resonant frequencies in the ductwork.

It is important to mount flexible inlet duct connections with the correct amount of slack. Figure 8A shows a cross section of a properly mounted flexible connection. There is just enough slack in the connection to allow movement between the fan and ductwork. Figure 8B shows an improperly mounted connection, with an excessive amount of slack. Because of the negative pressure at the inlet, the extra material is sucked in. This

Figure 8A.

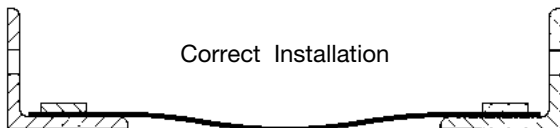
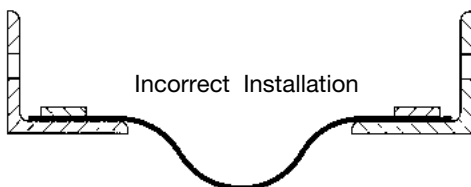

Figure 8B.



creates an obstruction at the fan inlet and results in a system effect on fan performance. On some fan designs, this obstruction also causes an increase in the sound levels produced by the fan. Increases as high as 20db in the blade pass frequency have been observed.

In some cases fans rigidly mounted to their supports need flexible duct connections. Fans handling high temperature air need to have flexible connections in order to absorb the thermal expansion of the ductwork. The ends of large plenums can deflect due to pressure loading. Ductwork connecting plenums to fans needs to have flexible connections to prevent the transmission of these deflections to the fan. In both of these cases, flexible connections allow room for duct movement without damaging the fan.

Be careful when using a fan to support ductwork, or when using ductwork to support a fan. Most fans are not designed to carry these external loads and adding them to the fan may cause the impeller to rub or cause other misalignments that could damage the fan. Check with the fan manufacturer before mounting the fan or ductwork this way to make sure the fan design can handle the loads.

Fan Startup

Figure 9 is a typical pre-startup checklist. Before starting a fan go through the checklist to make sure the fan is ready to run. Pay particular attention to safety. Be sure to lock off electrical power before working on any fan. Do not assume that because the factory tightened the fasteners and aligned the belt drives or couplings at the

Figure 9. Pre-Startup Checklist

Verify that proper safety precautions have been followed:

- Electrical power must be locked off

Check fan mechanism components:

- Nuts, bolts and set screws are tight.
- System connections are properly made and tightened.
- Bearings are properly lubricated.
- Impeller, drives and fan surfaces are clean and free of debris.
- Rotating assembly turns freely and does not rub.
- Drives are on correct shafts, properly aligned and properly tensioned.

Check fan electrical components:

- Motor is wired for proper supply voltage.
- Motor was properly sized for power and rotational inertia of the rotating assembly.
- Motor is properly grounded.
- All leads are properly insulated.

Trial “bump”

- Turn on power just long enough to start assembly rotating.
- Check rotation for agreement with the rotation arrow.
Does the assembly make any unusual noise?

Correct any problems which may have been found. (Follow safety guidelines. Make sure electrical power to the fan is locked off.) Perform checklist again until the fan is operating properly.

Run up to speed:

- Are bearing temperatures acceptable (<200°F) after one to two hours of operation?
- Check for excess levels of vibration.

After one week of operation:

- Check all nuts, bolts and setscrews and tighten if necessary.

factory that they still will be tight and/or aligned when starting the fan at the jobsite. Fasteners can loosen during shipment and handling and parts can move out of alignment.

Figure 10. Sheave & belt alignment(s)

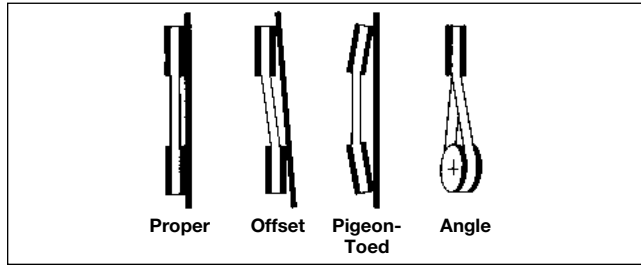

For belt driven fans, proper belt alignment is critical for long belt life. Misaligned sheaves cause uneven belt wear and additional flexing of the belt, both of which reduce the life of the belt. Figure 10 shows properly aligned sheaves, sheaves with offset misalignment and sheaves with two types of angular misalignment. The diagram also shows a straightedge laid across the sheaves. With properly aligned sheaves, the straightedge contacts the entire face of both sheaves.

Proper belt tension is also important for long belt life. Too much tension puts excessive loads on the belts and the bearings, reducing the lives of both components. Not enough tension allows belt slippage which generates heat and drastically reduces the life of the belt.

Figure 11. Belt tensioning

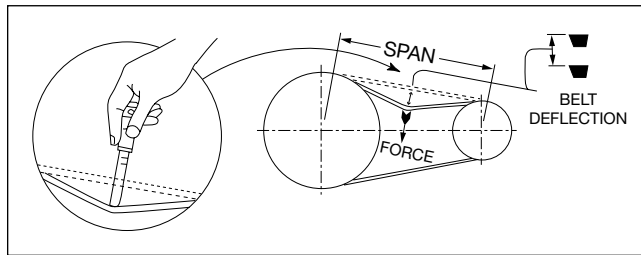

Belt tensioning gauges, such as the one shown in Figure 11, can be used to determine whether the belts are tensioned properly. A chart that comes with the gauge specifies a range of force required to deflect the belts a given amount based on the center distance of the sheaves and the belt cross section. The belts are properly tensioned when the force required to deflect the belt the specified amount falls within this range.

If a belt tensioning gauge is not available, re-tension the belts just tight enough so that they do not squeal when starting the fan. A short “chirp” is acceptable; a squeal lasting several seconds or longer is not.

Before starting the fan after tensioning the belts, recheck the alignment and realign the sheaves if necessary. New belts may stretch a little at first, so recheck belt tension after a few days of operation.

Bearing Lubrication

Inadequate bearing lubrication is the most common cause of fan problems. Lubrication is inadequate if there is not enough lubricant, too infrequent relubrication, or relubrication with the wrong type of lubricant. Most fans ship from the factory with a lubrication label similar to the one in Figure 12. These labels usually specify the amount of lubricant to add at an interval based on the

bearing size and speed. This interval will be appropriate for most installations, but in some cases it will be necessary to adjust the relubrication interval. The factors that affect the relubrication interval are bearing size, speed, the ambient temperature around the bearings, the fan airstream temperature, how wet, dirty or corrosive the operating conditions are and the shaft orientation. With installations that are wet, dirty, or corrosive, it is necessary to add new grease more frequently. This flushes contaminants out of the bearings before they work their way into the rolling portion of the bearing. High temperatures tend to break down the lubricants, so they require more frequent replenishment. Bearings with surface temperatures over 150°F may need special high temperature duty grease. It is much easier for the grease to leak out of the seals of bearings mounted on vertical shafts, so they need relubrication about twice as often as horizontal shaft applications.

The best way to determine the relubrication frequency is to inspect the condition of the old grease that purges from the seals when adding new grease. If the purged grease looks just like the new grease, you can go a longer time between relubrications. If the purged grease is much darker than the new grease, this indicates that the grease is oxidized and you must relubricate more frequently.

There are many types of grease on the market, manufactured from various bases. Lithium-based greases are the most common. Be careful when mixing greases of different bases. For example, mixing a calcium-based grease with a lithium-based grease will create a mixture that hardens and does not provide adequate lubrication. Before using or adding a grease with a different base,

Figure 12. Spherical Roller Bearing Relubrication Schedule

WARNING

- This equipment must not be operated without proper guarding of all moving parts. While performing maintenance be sure remote power switches are locked off. See AMCA Publication 410 for recommended safety practices.
- Before starting: Check all set screws for tightness and rotate impeller by hand to make sure it has not moved in transit.

RELUBRICATION SCHEDULE (MONTHS)*										
SPHERICAL ROLLER BEARINGS (SPLIT) PILLOW BLOCKS										
SPEED (RPM)	500	700	1000	1500	2000	2500	3000	3500	4000	Grease To Be Added At Each Interval
SHAFT DIAMETER										
1 7/16" thru 1 5/16"	6	4 1/2	4	4	3 1/2	2 1/2	2 1/2	1	1	0.50 Oz.
2 3/16" thru 2 1/16"	5	4 1/2	4	2 1/2	2 1/2	1 1/2	1/2	1/4	1/4	0.75 Oz.
2 15/16" thru 3 15/16"	4 1/2	4	3 1/2	2 1/2	1 1/2	1	1/2			2.00 Oz.
4 7/16" thru 4 15/16"	4	4	2 1/2	1	1/2					4.00 Oz.
5 7/16" thru 5 15/16"	4	2 1/2	1 1/2	1						7.00 Oz.

*Suggested initial greasing interval — remove bearing cap and observe condition of used grease after lubricating. Adjust lubrication frequency as needed. Hours of operation, temperature and surrounding conditions will affect the relubrication frequency required. Clean and repack bearings annually. Remove old grease, pack bearing full and fill housing reservoirs on both sides of bearing to bottom of shaft.

- Lubricate with a multipurpose roller bearing NLGI grade 2 having rust inhibitors and antioxidant additives and a minimum oil viscosity of 500 SUS at 100°F. Some greases having these properties are:
 - Shell — Alvania No. 2 Texaco — Premium RB2
 - Mobil — Mobilith SHC 100 Amoco — Rykon Premium 2
- Lubricate bearings prior to extended shutdown or storage and rotate shaft monthly to aid corrosion protection.

STATIC OIL LUBRICATION

- Use only highest quality mineral oil with a minimum viscosity of 100 SUS at the oil's operation temperature. The oil's operating temperature is approximately 10° greater than the bearing's housing. SAE values having this viscosity at the following operating temperatures are: 150°F – SAE 20; 160°F – SAE 30; 180°F – SAE 40.
- Static oil level should be at the center of the lowermost roller (do not overfill).
- Complete lubricant change should be made annually.

Twin City Fan Companies, Ltd.

Designers & Manufacturers of Air Moving Equipment

the old grease must be cleaned from the bearings. Be careful of very high temperature greases. The bond between the oil and the thickener may be so great that the oil won't release at operating temperature. The bearing runs "dry" despite being apparently filled with grease.

As a fan operates over a period of time, it is not unusual for vibration levels to gradually increase. This can be due to wear, buildup of foreign material on the rotating parts, or other effects. Fan operation is much more reliable when using periodic vibration readings to monitor vibration levels and by taking corrective actions before the vibrations get too high.

It is possible to use vibration spectra as part of a predictive maintenance program to detect wear in bearings. By analyzing spectra taken at regular intervals it is possible to predict when a bearing will fail. Corrective action can then be taken at a scheduled shutdown instead of at an unscheduled breakdown.

AMCA Standard 204-94 contains industry accepted criteria for determining at which point vibration levels are too high. This standard categorizes fans based on application and horsepower. The categories range from BV-1, for small, low horsepower residential fans to BV-5 for critical vibration-sensitive applications such as computer chip manufacturing. Most industrial fans fall into the BV-3 or BV-4 category.

Once the fan application category is determined, the standard gives startup, alarm and shutdown vibration limits. According to the standard, for BV-3 category fans

rigidly mounted, the startup overall vibration levels should be below 0.25 inches per second (ips), the alarm level is 0.4 ips and the shutdown level is 0.50 ips. Once the vibration levels reach the alarm level, determine the cause of the high levels and schedule corrective action for the next shutdown. Monitor the vibration levels closely. If the levels reach the shutdown level, take corrective action immediately. Continued operation may cause permanent damage to fan components and an eventual catastrophic failure.

Overall vibration levels include the vibration at all frequencies. Upon reaching a high level of vibration, a vibration spectrum is a useful tool in determining what component of the fan is causing the problem. Following are items to check:

- Check the background vibration levels (the vibration may not be coming from the fan).
- Review the pre-startup checklist.
- Clean the impeller.
- Check for worn motor, bearings, belts, or sheaves.
- Check the fan foundation for looseness or cracks.
- Perform a trim balance.

Conclusion

By following proper storage, installation, operation and maintenance guidelines, the majority of fan problems can be avoided, minimizing downtime and maximizing the life and efficiency of the fan.



WWW.AEROVENT.COM

5959 TRENTON LANE N. | MINNEAPOLIS, MN 55442 | PHONE: 763-551-7500 | FAX: 763-551-7501

©2021 TWIN CITY FAN COMPANIES, LTD.